

Modular set layout sheet

(project B part1)

ITGM 352 Environment and level designing

Student Name: John Cornacchioli

QTR: Spring

Sec: OL

Project Title: Dystopian Future

Modular set: Circle_A

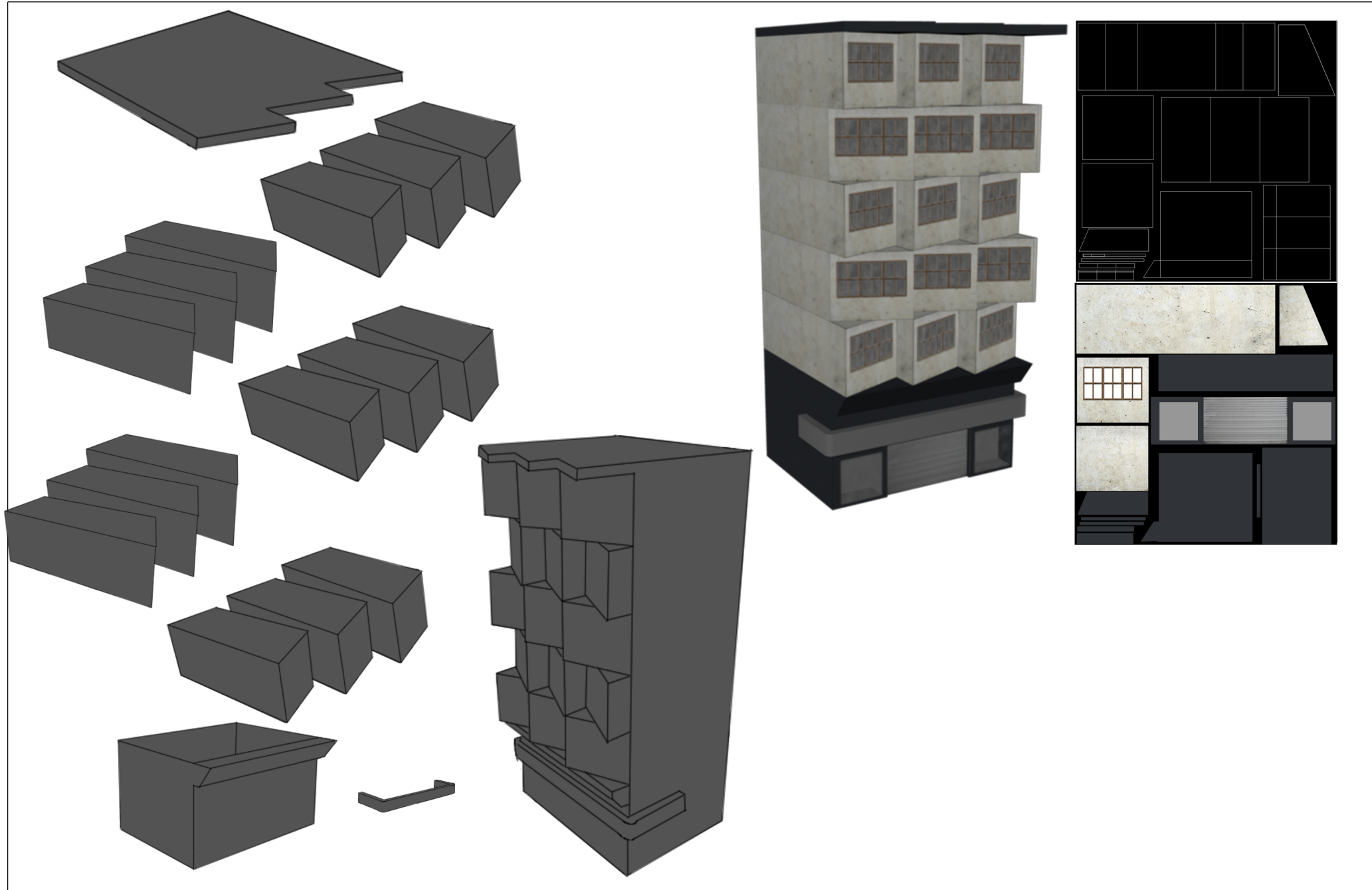

Modular set layout sheet

(project B part1)

ITGM 352 Environment and level designing

Student Name: John Cornacchioli

QTR: Spring

Sec: OL

Project Title: Dystopian Future

Modular set: Hospital

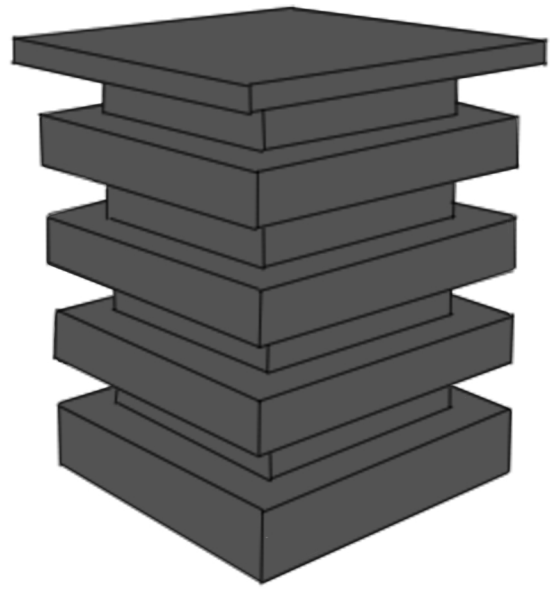
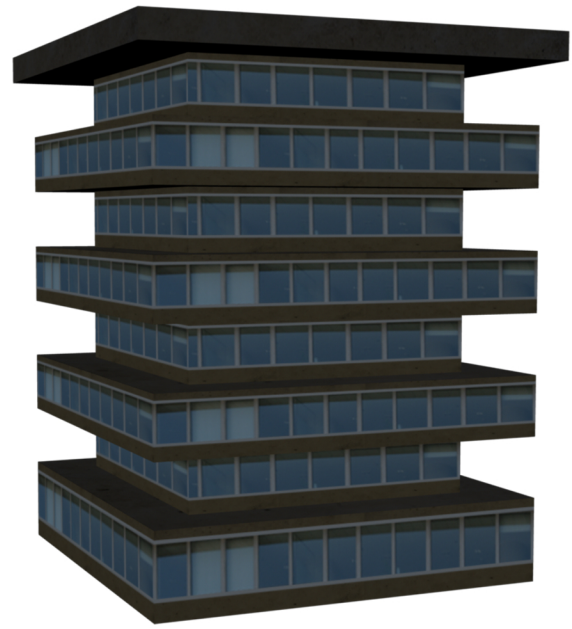
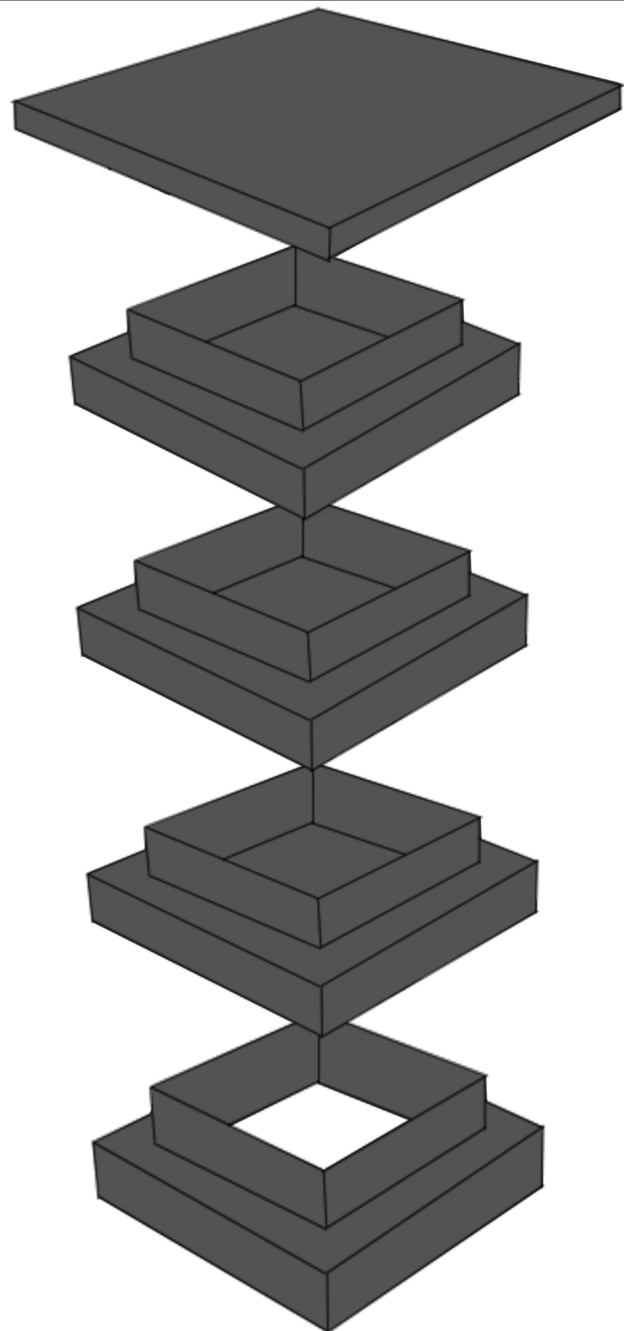

Modular set layout sheet

(project B part1)

ITGM 352 Environment and level designing

Student Name: John Cornacchioli

QTR: Spring

Sec: OL

Project Title: Dystopian Future

Modular set: Automat

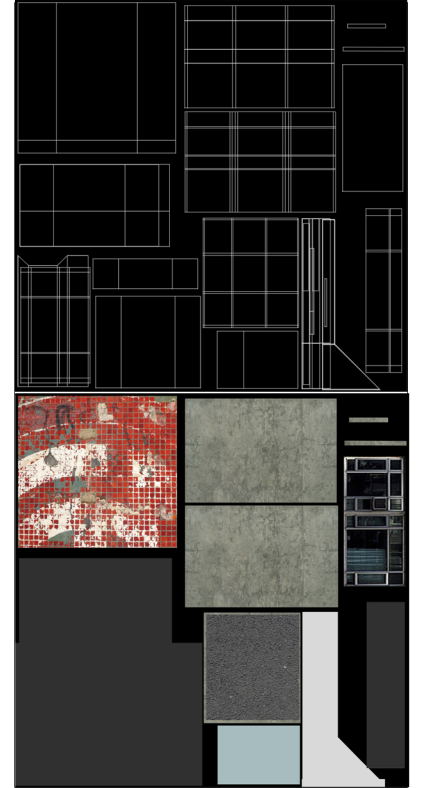
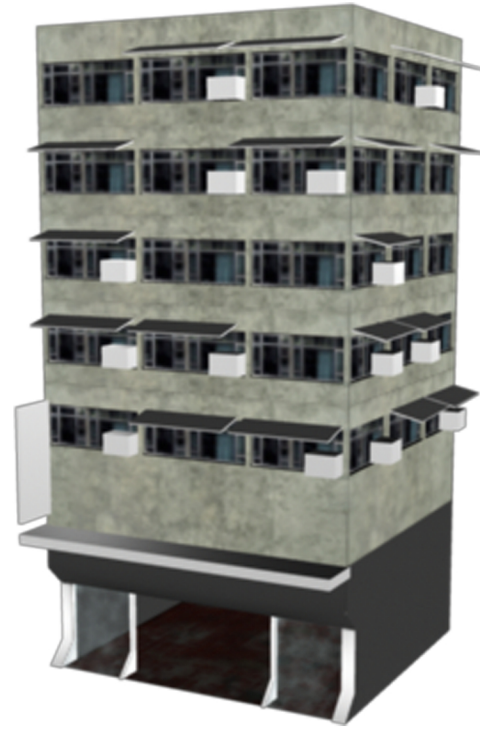
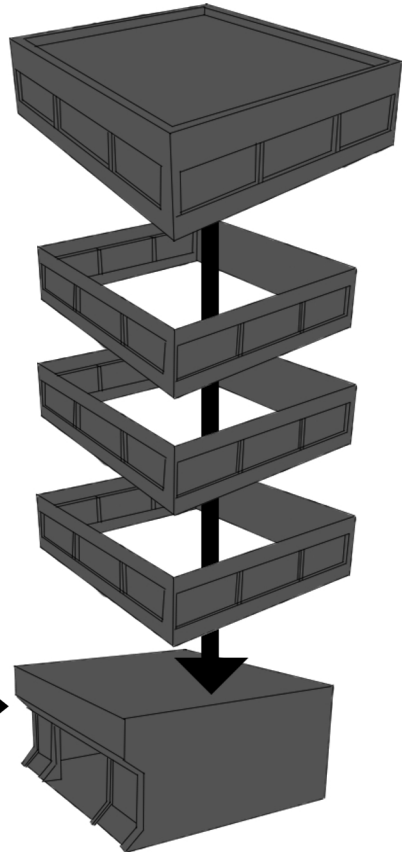
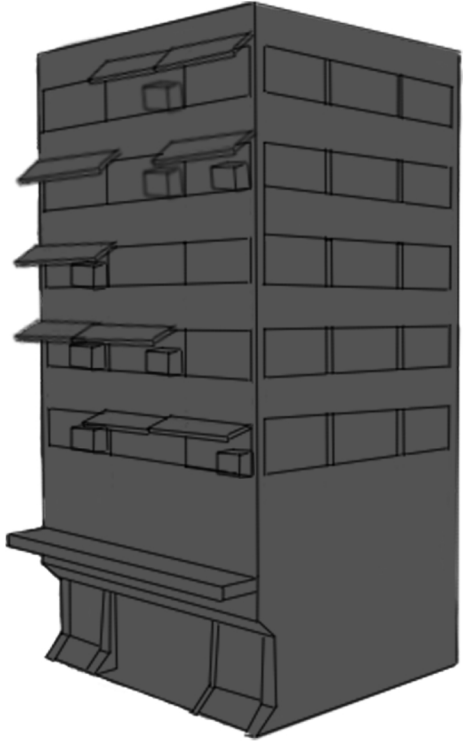

Modular set layout sheet

(project B part1)

ITGM 352 Environment and level designing

Student Name: John Cornacchioli

QTR: Spring

Sec: 0L

Project Title: Dystopian Future

Modular set: Augmentation Center

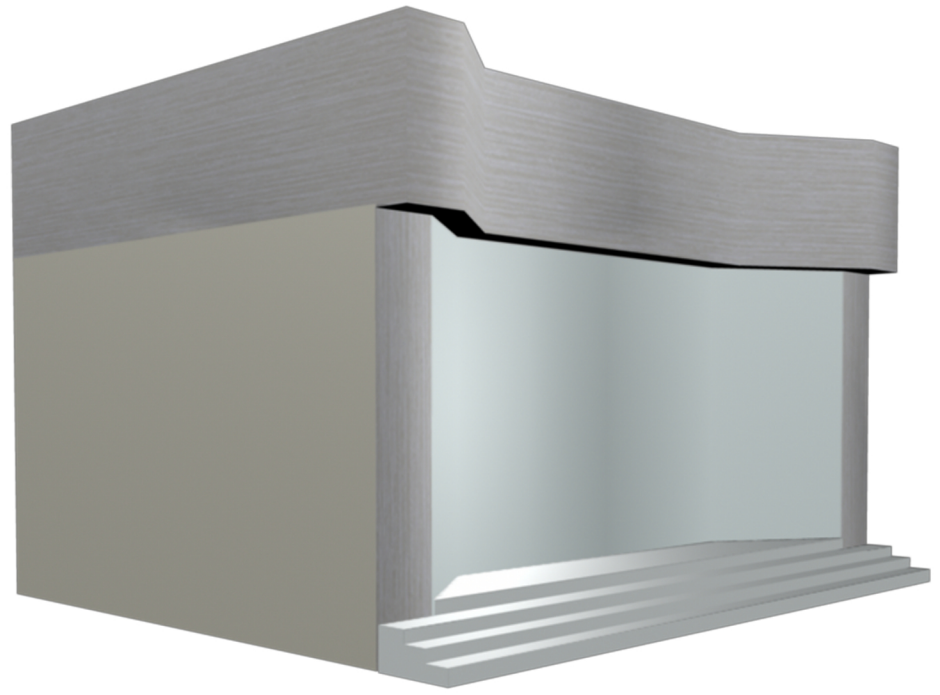
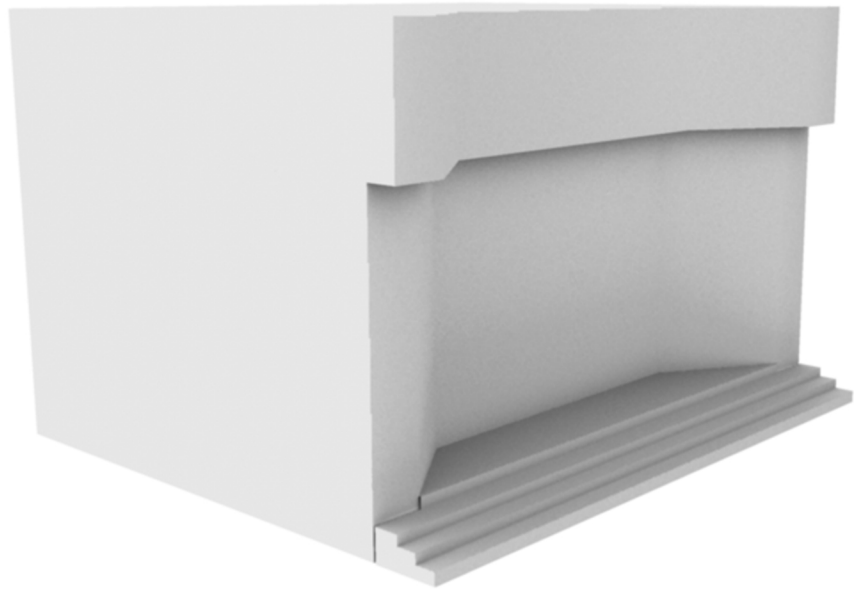
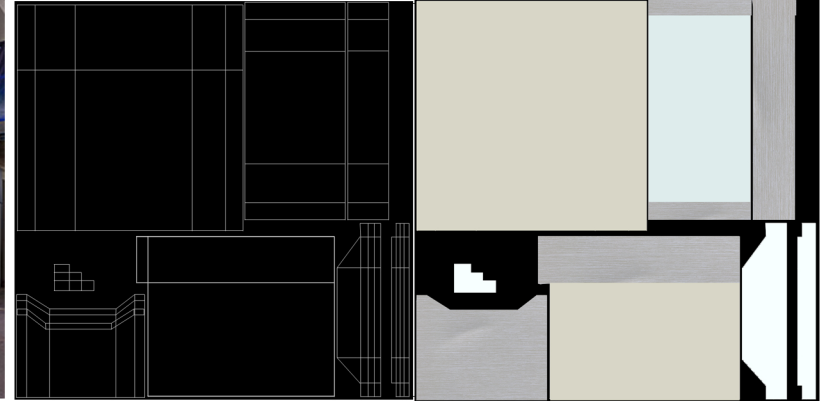
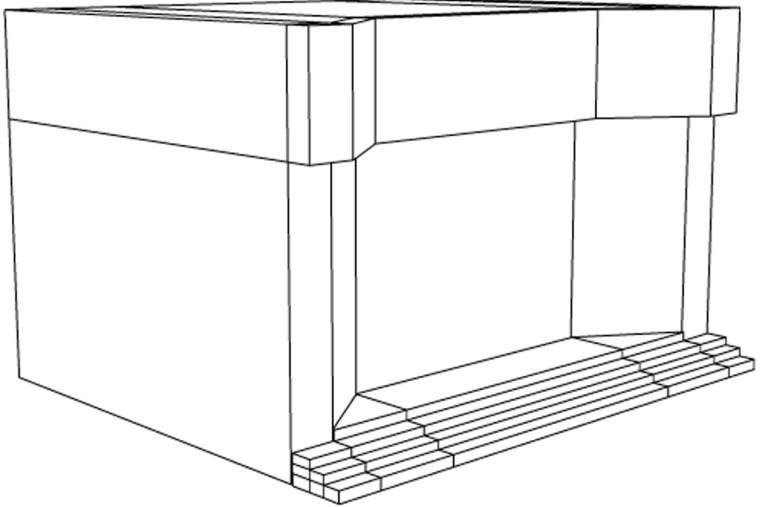

Modular set layout sheet

(project B part1)

ITGM 352 Environment and level designing

Student Name: John Cornacchioli

QTR: Spring

Sec: OL

Project Title: Dystopian Future

Modular set: Automat

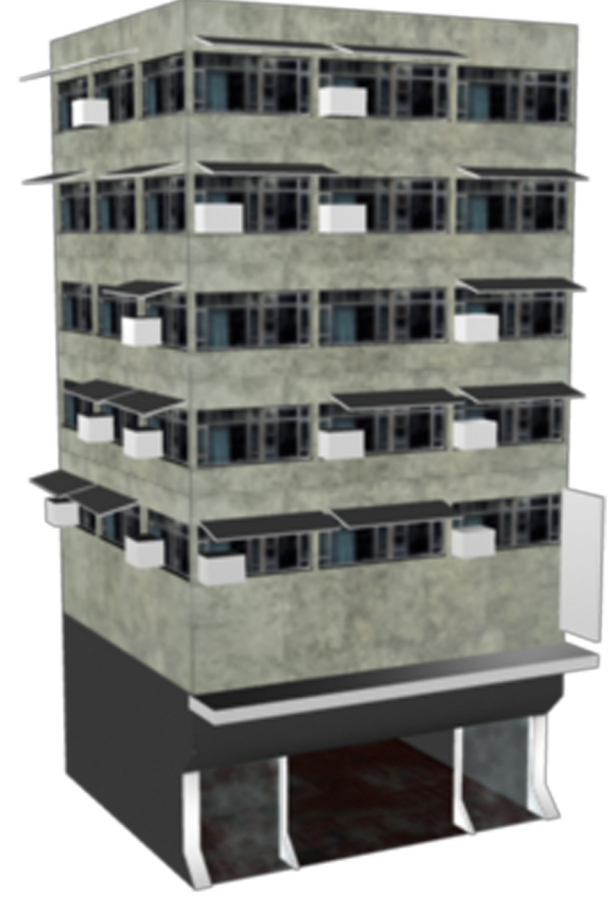
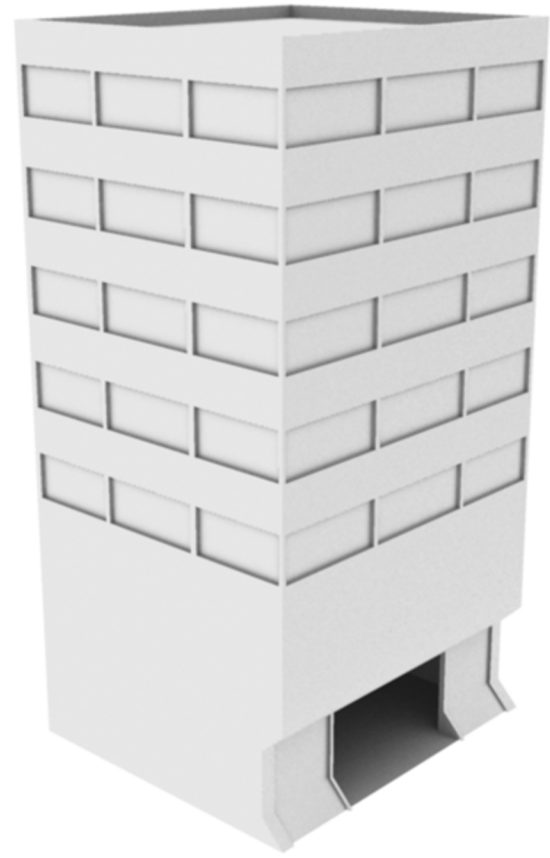
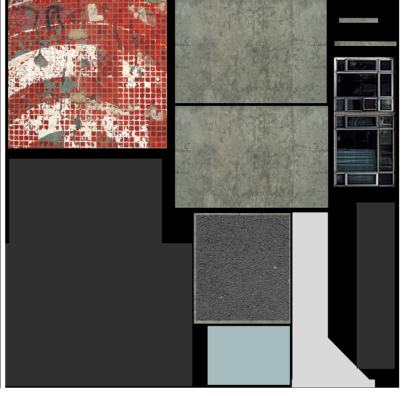
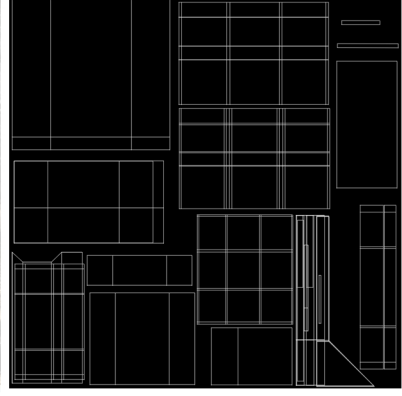
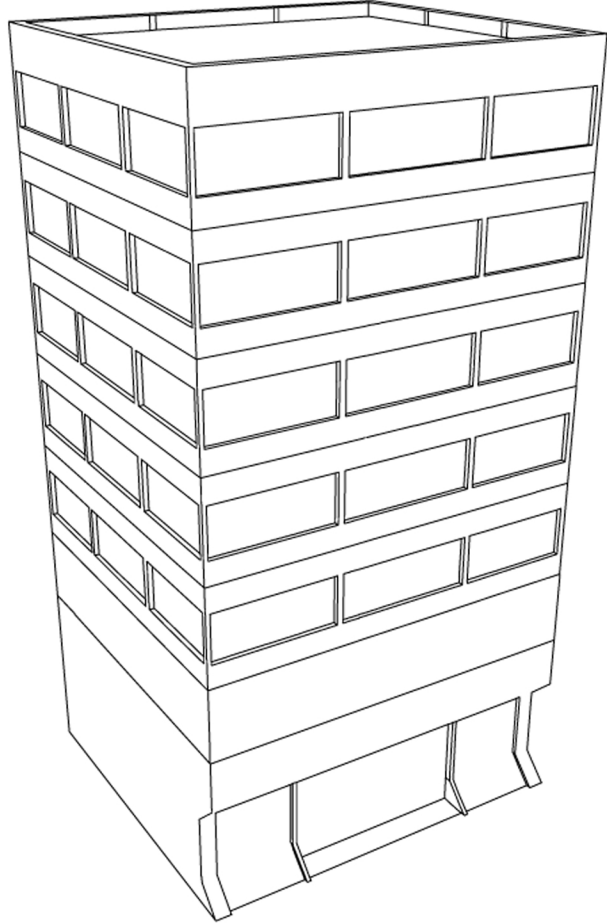

Modular set layout sheet

(project B part1)

ITGM 352 Environment and level designing

Student Name: John Cornacchioli

QTR: Spring

Sec: OL

Project Title: Dystopian Future

Modular set: Billboard

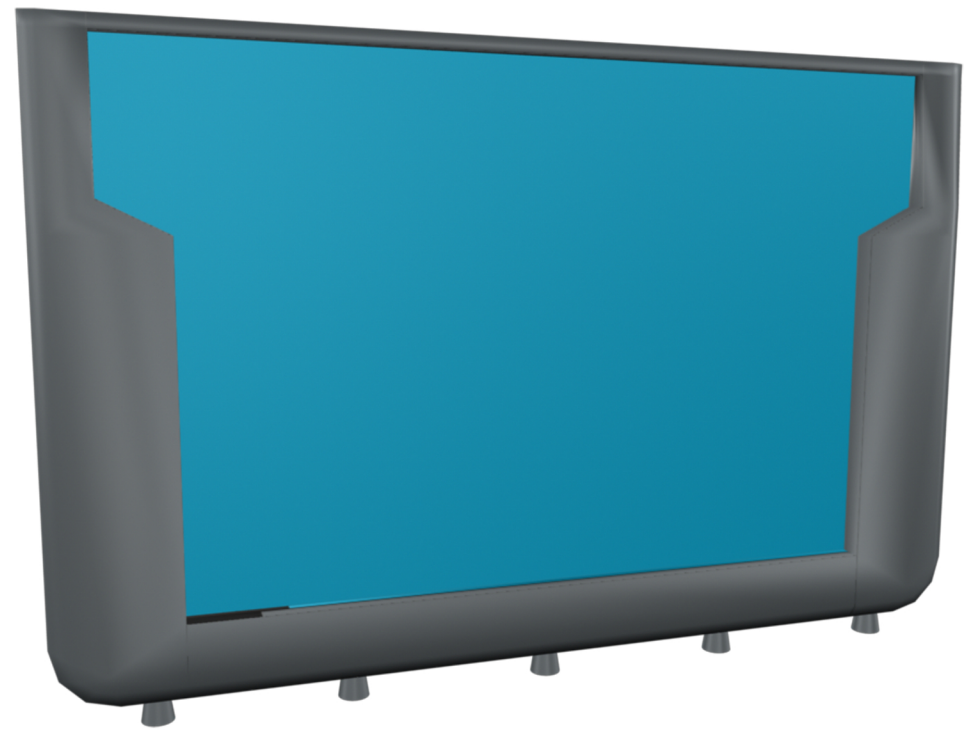
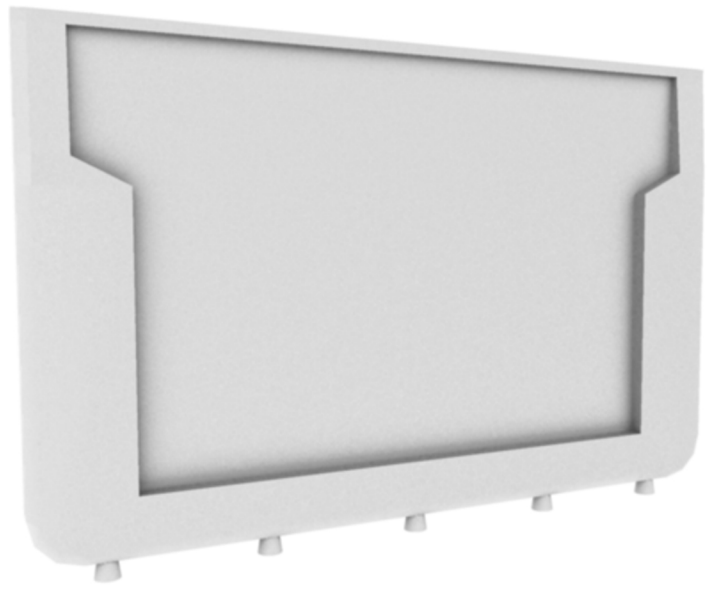
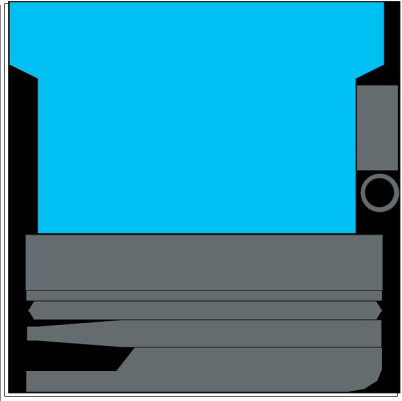
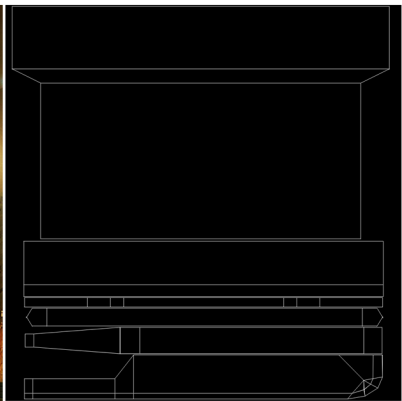
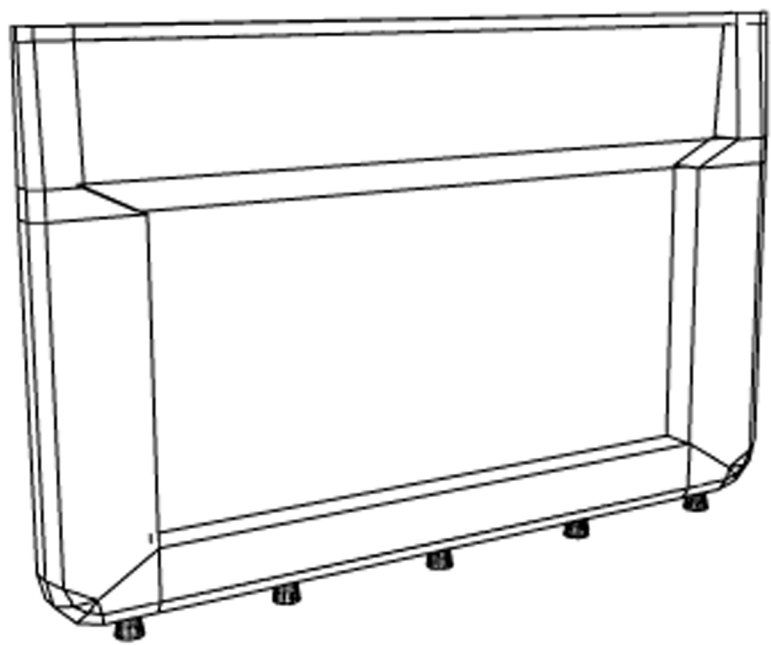

Modular set layout sheet

(project B part1)

ITGM 352 Environment and level designing

Student Name: John Cornacchioli

QTR: Spring

Sec: OL

Project Title: Dystopian Future

Modular set: Circle_A

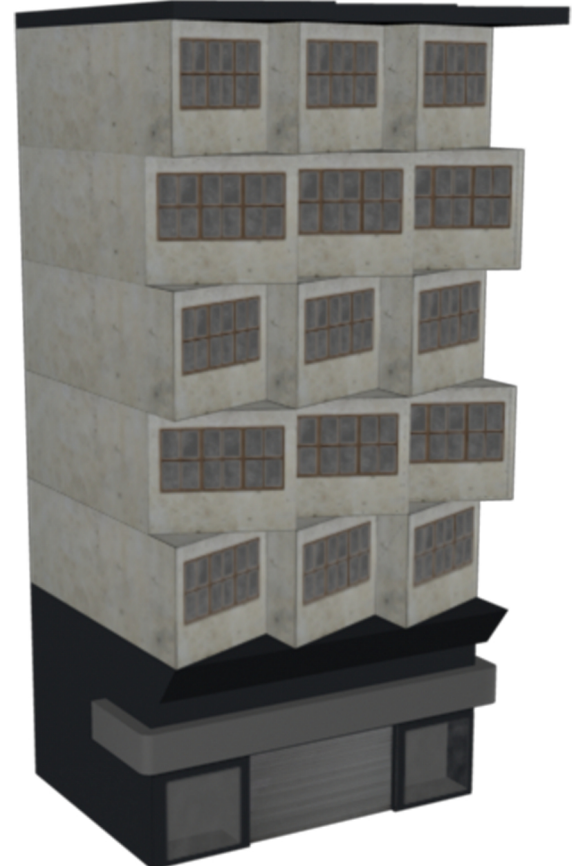
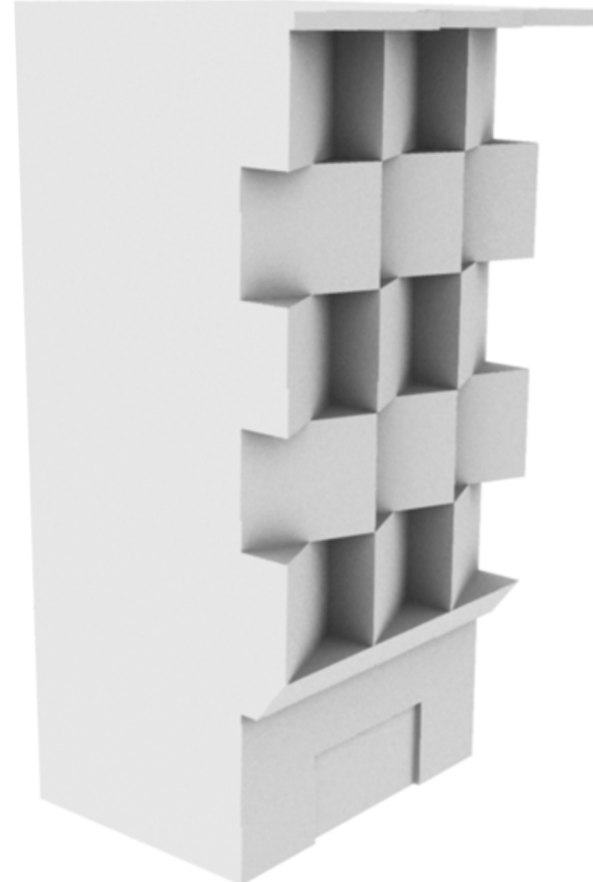
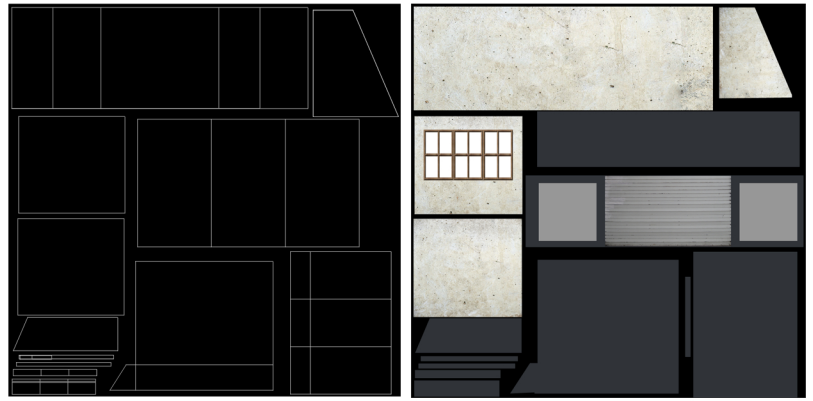
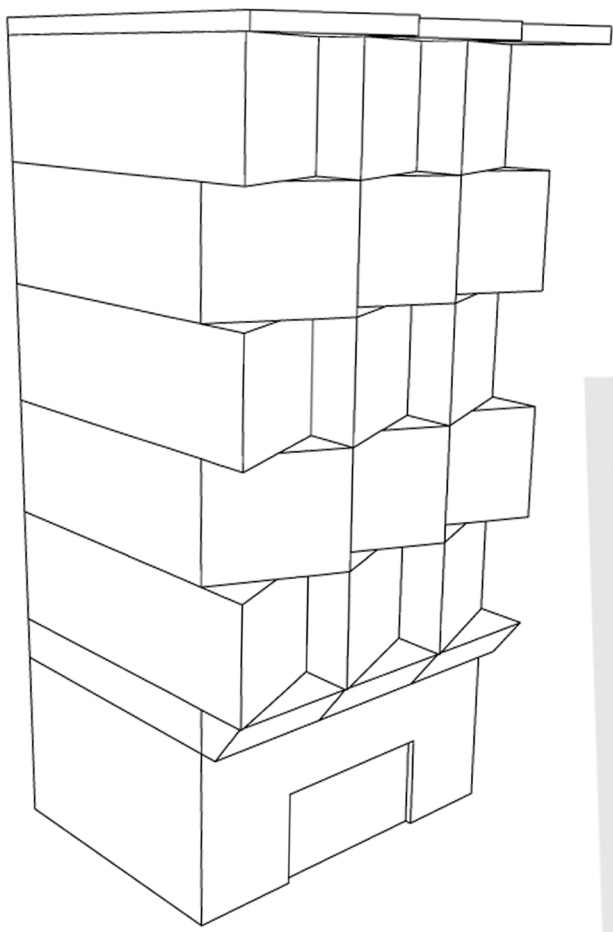

Modular set layout sheet

(project B part1)

ITGM 352 Environment and level designing

Student Name: John Cornacchioli

QTR: Spring

Sec: 0L

Project Title: Dystopian Future

Modular set: Crate & Fence

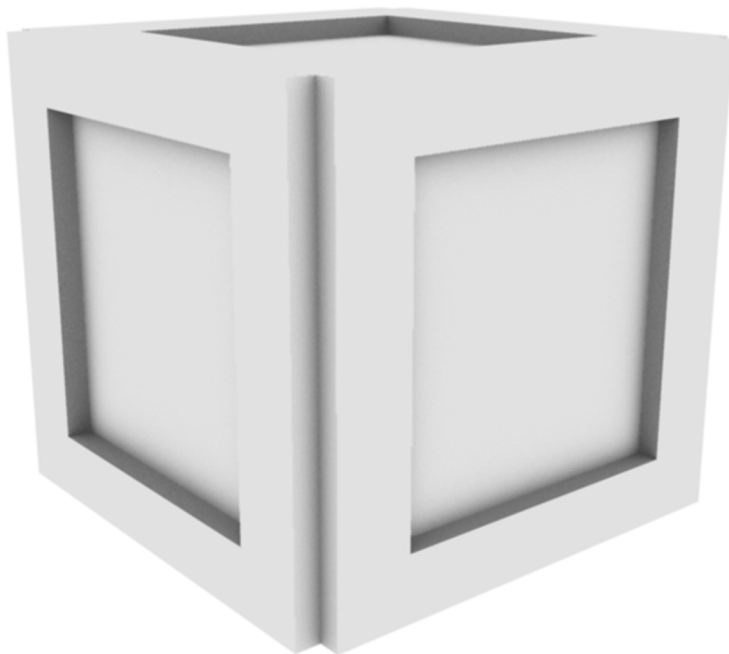
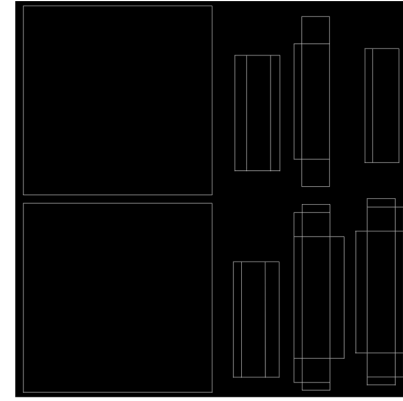
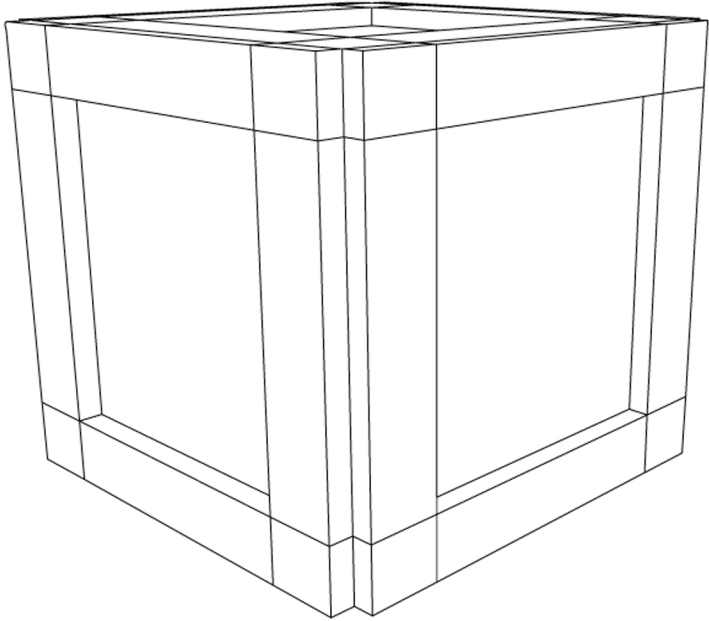

Modular set layout sheet

(project B part1)

ITGM 352 Environment and level designing

Student Name: John Cornacchioli

QTR: Spring

Sec: OL

Project Title: Dystopian Future

Modular set: Hospital

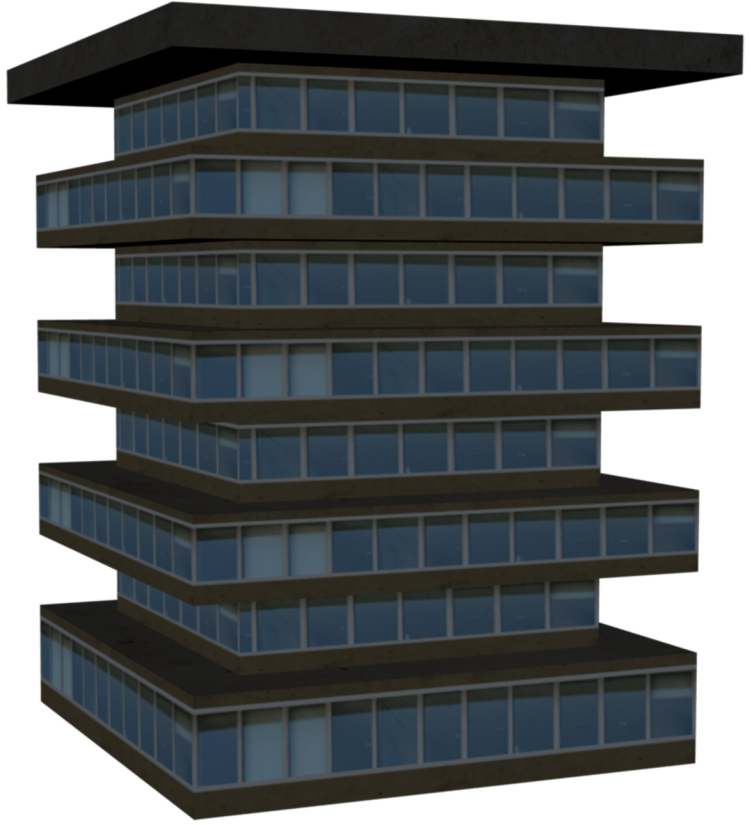
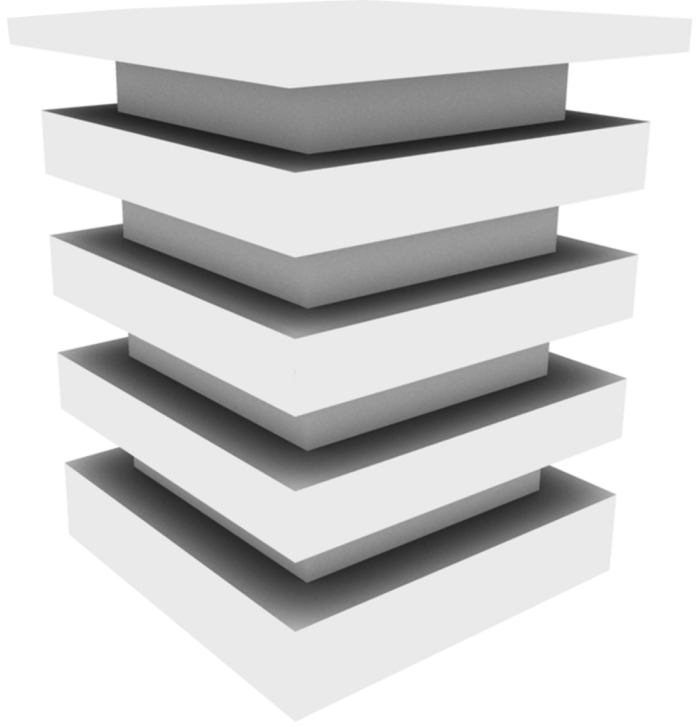
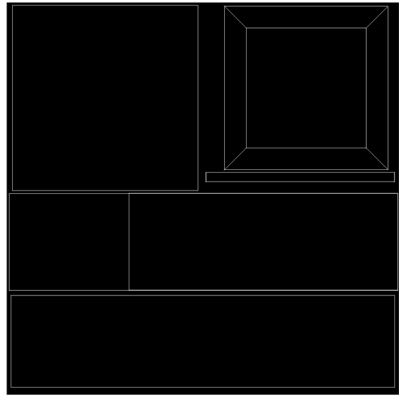
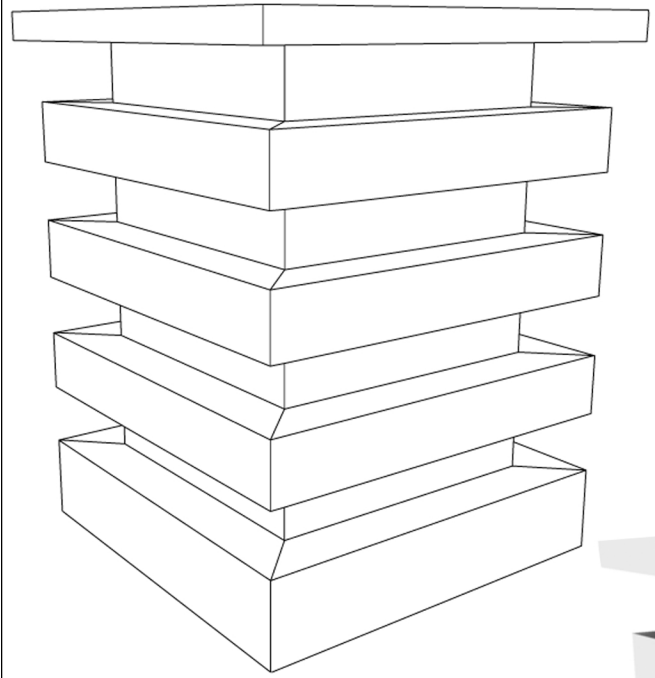

Modular set layout sheet

(project B part1)

ITGM 352 Environment and level designing

Student Name: John Cornacchioli

QTR: Spring

Sec: OL

Project Title: Dystopian Future

Modular set: Shrine

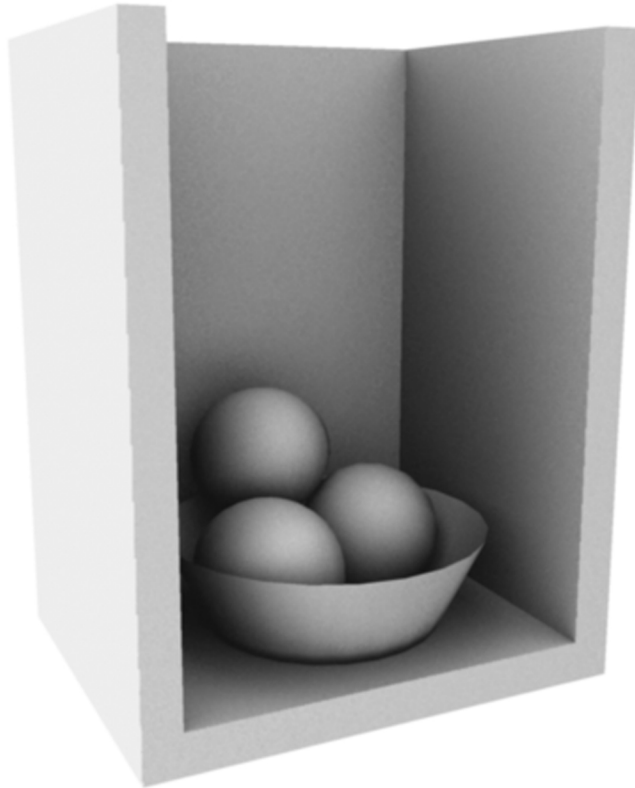
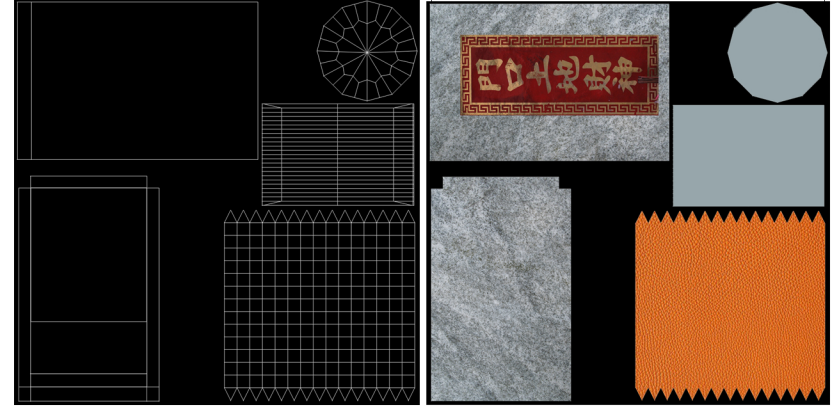
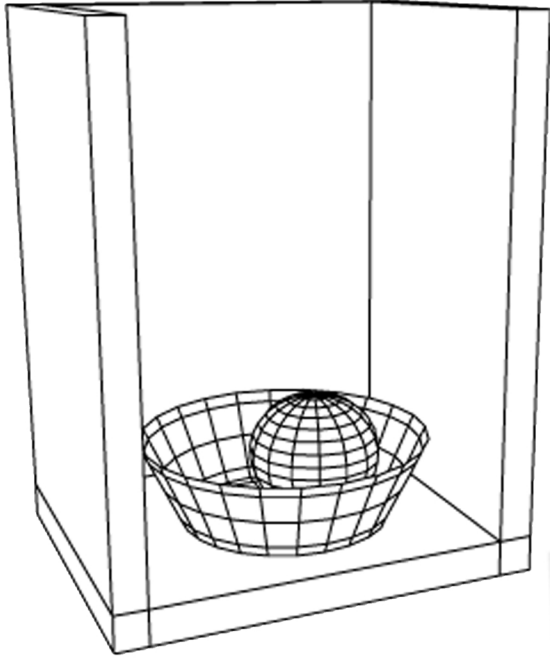

Modular set layout sheet

(project B part1)

ITGM 352 Environment and level designing

Student Name: John Cornacchioli

QTR: Spring

Sec: DL

Project Title: Dystopian Future

Modular set: Vending Machine, Bottle & Can



Modular set layout sheet

(project B part1)

ITGM 352 Environment and level designing

Student Name: John Cornacchioli

QTR: Spring

Sec: OL

Project Title: Dystopian Future

Modular set: WareHouse

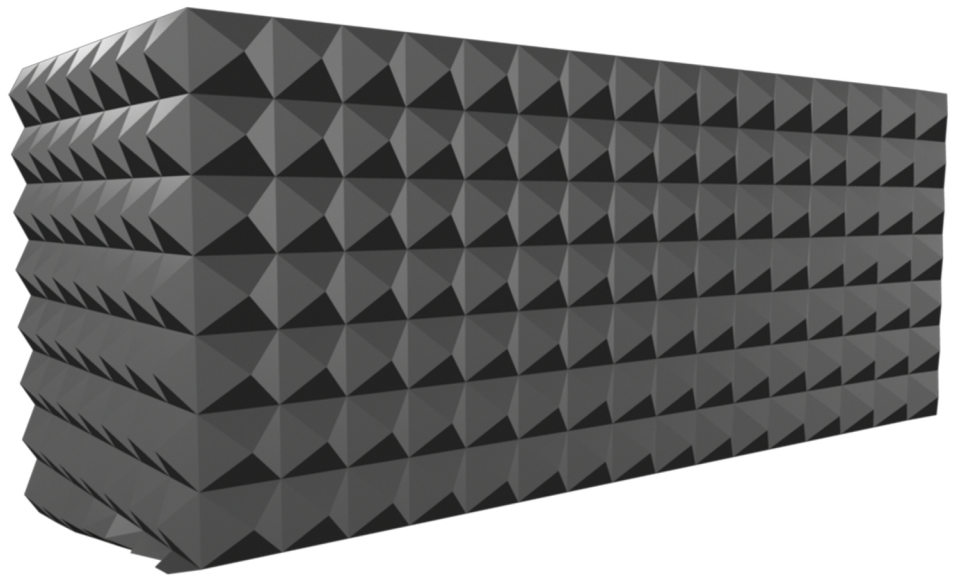
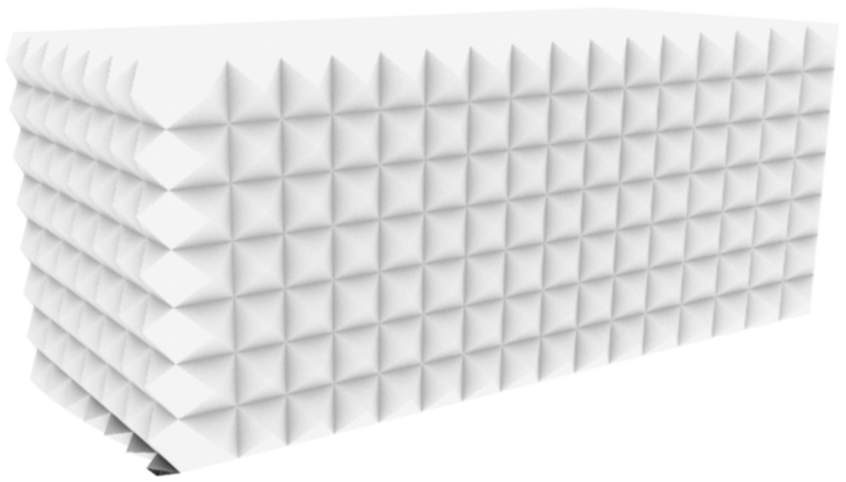
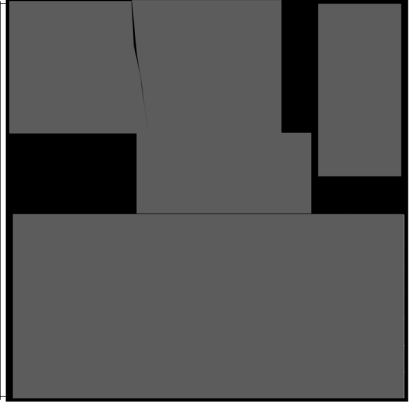
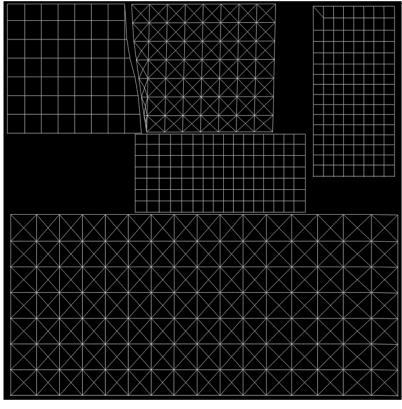
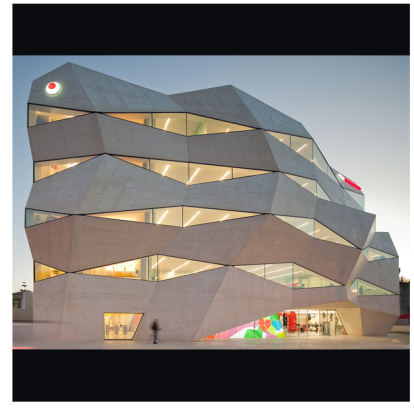
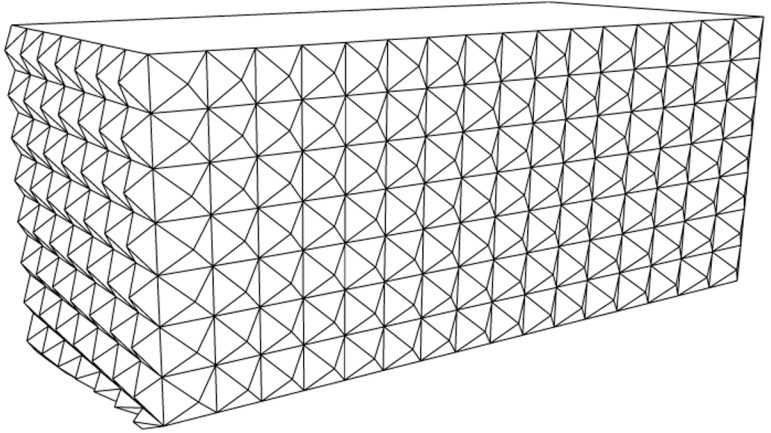

Modular set layout sheet

(project B part1)

ITGM 352 Environment and level designing

Student Name: John Cornacchioli

QTR: Spring

Sec: 0L

Project Title: Dystopian Future

Modular set: Wooden Palett, Oil Drum & Trash Can

